

For more advanced set up, monitoring options,  
or to use the MV7 with conferencing applications,  
head to the online user guide at [shure.com](https://www.shure.com)

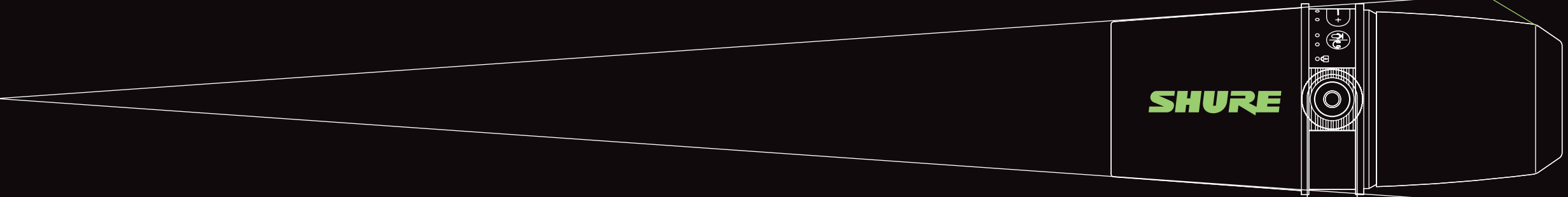

**MV7**  
PODCAST  
MICROPHONE

**QUICK  
START  
GUIDE**

©2020 Shure Incorporated.  
SHURE and the SHURE logotype are registered trademarks of Shure Incorporated or  
Shure Acquisition Holdings, Inc. For additional information, see [shure.com/trademarks](https://www.shure.com/trademarks).  
Patents: [shure.com/patents](https://www.shure.com/patents)

# CONNECT

## VIA XLR

---

If using the MV7 via XLR, simply connect the microphone to an audio interface or mixer and start creating.

\*Note, the touch panel on the microphone will not be activated when using the microphone via XLR

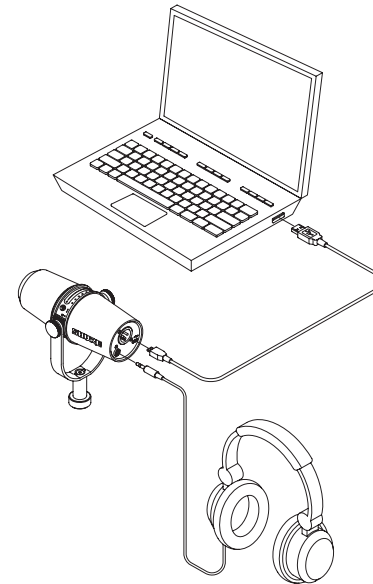
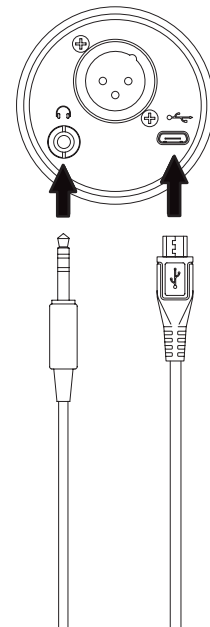
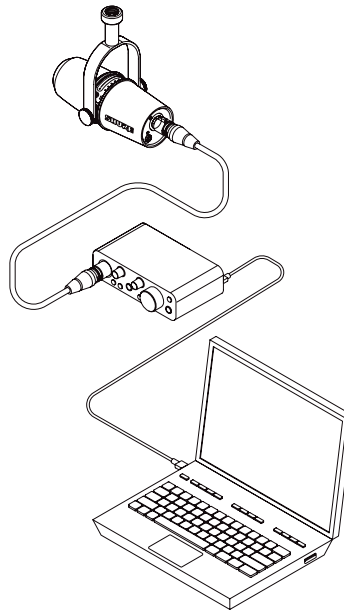
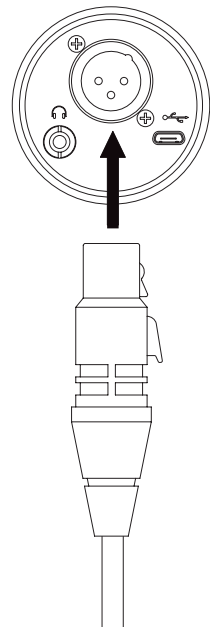

# CONNECT

## VIA USB

---

If using the MV7 via USB, you will need to download the ShurePlus MOTIV App for ultimate control (available at [Shure.com/MOTIVdesktop](https://Shure.com/MOTIVdesktop))



# USB TOUCH PANEL

When using the MV7 via USB you can control the microphone using the touch panel.

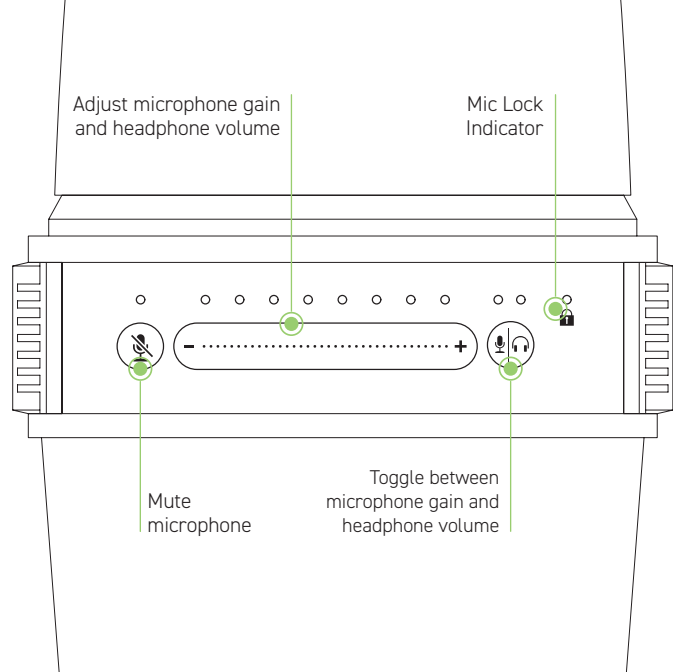

## TOUCH PANEL OPERATION

### TOGGLE: MICROPHONE \ HEADPHONE



**TAP** to toggle between Microphone Gain and Headphone Volume, then dial in your preferred settings by **SLIDING** your finger along the touch panel.

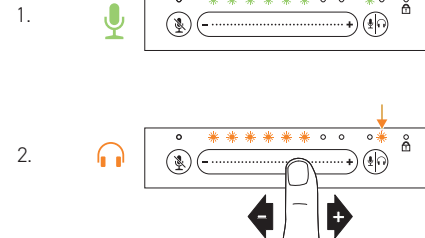

### MONITOR MIX



**HOLD** for 2 seconds to access Monitor Mix, then dial in your preferred mix.

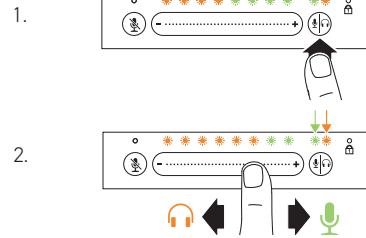

### LOCK / UNLOCK TOUCH PANEL



**HOLD BOTH** for 2 seconds to lock/unlock touch panel

### TOGGLE: MUTE / UNMUTE MICROPHONE

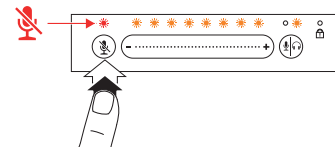

If the LED above the headphone icon is **FLASHING**, please see the online User Guide.



## SHUREPLUS MOTIV™ APP

# AT A GLANCE

Please visit [Shure.com/MOTIVdesktop](https://www.shure.com/MOTIVdesktop) to download the MOTIV App for Mac or Windows. Once installed, choose from Auto Level Mode, where EQ, compression, and auto gaining are taken care of automatically, leaving you to focus on your production, or Manual Mode, where you are in control.

### MANUAL MODE

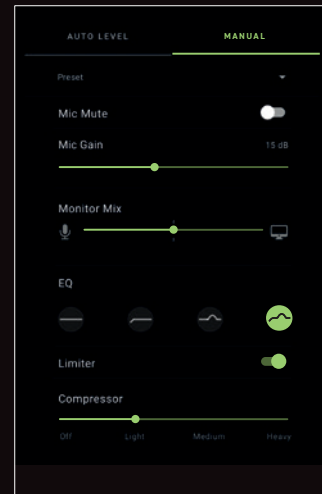

### AUTO LEVEL MODE

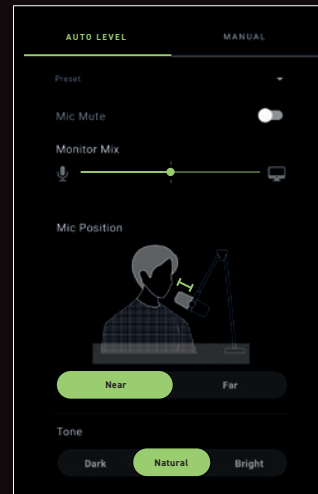

## CONTROL

The most exciting and unique feature of the ShurePlus MOTIV App is Auto Level Mode. Your voice and mic position are always changing. Auto Level Mode sets your gain perfectly in real-time, so your output level stays consistent. This allows you to focus on your content, not your mic technique and gives your audience a more consistent listening experience.

**MONITOR MIX** Mix between hearing yourself and your system audio

**MIC POSITION** Select **NEAR** if you are up to 6" away from your microphone, and **FAR** for 6-18".

Set to **NEAR**, Auto Level can prevent accidental clips and handle changes in level

Set to **FAR**, Auto Level will give you more gain at a lower noise than manual, allowing you to be farther away from the microphone with better performance and a much more consistent sound.

**TONE** Select **DARK** to emphasise low end for that classic broadcast sound

Select **NATURAL** to benefit from Auto Level Mode, but leaving your voice tone unaffected

Select **BRIGHT** to add clarity to your voice

**MIC GAIN** Adjust your recording level

**EQ** Choose from 4 EQ presets to tailor your voice

**LIMITER** Apply to prevent clipping in your recordings or streams

**COMPRESSOR** Keep your audio levels consistent by applying compression to suit your needs