

2 Channel Audio Isolation Transformer

DAC-80



Quick Start Guide

Warranty

Standard Warranty

- ◆ Datavideo equipment is guaranteed against any manufacturing defects for one year from the date of purchase.
- ◆ The original purchase invoice or other documentary evidence should be supplied at the time of any request for repair under warranty.
- ◆ Damage caused by accident, misuse, unauthorized repairs, sand, grit or water is not covered by this warranty.
- ◆ All mail or transportation costs including insurance are at the expense of the owner.
- ◆ All other claims of any nature are not covered.
- ◆ Cables & batteries are not covered under warranty.
- ◆ Warranty only valid within the country or region of purchase.
- ◆ Your statutory rights are not affected.

Two Year Warranty

- ◆ All Datavideo products purchased after 01-Oct.-2008 qualify for a free one year extension to the standard Warranty, providing the product is registered with Datavideo within 30 days of purchase. For information on how to register please visit www.datavideo-tek.com or contact your local Datavideo office or authorized Distributors
- ◆ Certain parts with limited lifetime expectancy such as LCD Panels, DVD Drives, Hard Drives are only covered for the first 10,000 hours, or 1 year (whichever comes first).

Any second year warranty claims must be made to your local Datavideo office or one of its authorized Distributors before the extended warranty expires.

Disposal



For EU Customers only - WEEE Marking

This symbol on the product indicates that it will not be treated as household waste. It must be handed over to the applicable take back scheme for the recycling of electrical and electronic equipment. For more detailed information about the recycling of this product, please contact your local Datavideo office.

Overview

DAC-80 is designed to remove hum and buzz created by ground loops. Normal voltage differences in the system grounding points between different pieces of equipment cause small AC power currents to flow in the shield of audio cables. Capacitance between a power transformer's primary and secondary windings introduce signals to the circuit ground which will also create small current flows in the cable shield. Either of these problems will create hum in audio signals. DAC-80 breaks the inter-equipment ground path and greatly increases the rejection in the input circuits while remaining transparent to the audio signal.

Features

- Easy to use
- Eliminate audio noise caused by ground loops
- Designed for low signal loss and low distortion
- Passive device (No power required)

Packing List

The following items should be included in the box. If any items are missing please contact your supplier.

- 1 x DAC-80
- 1 x Quick Start Guide

Front Panel

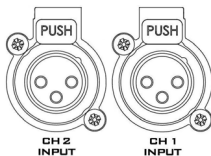
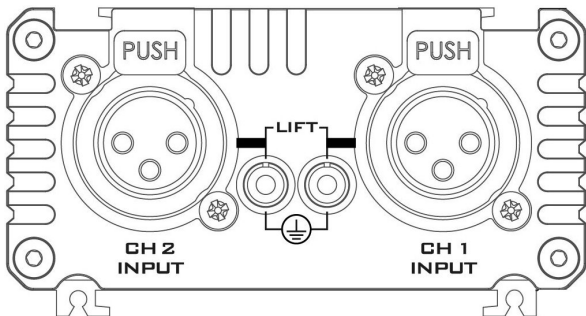

CH1 / CH2 Audio Input

XLR Balanced Audio input (Channel 1 / 2)

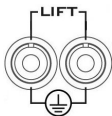

LIFT Toggle Switch

These switches turn to UP position, audio ground not connected. Breaks ground loops, provides audio isolation.

These switches turn to DOWN position, for chassis shield and audio ground connected. Corrects balance on audio lines.

(Left switch =CH2, Right switch = CH1)

Rear Panel

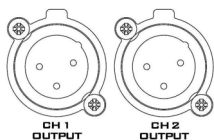
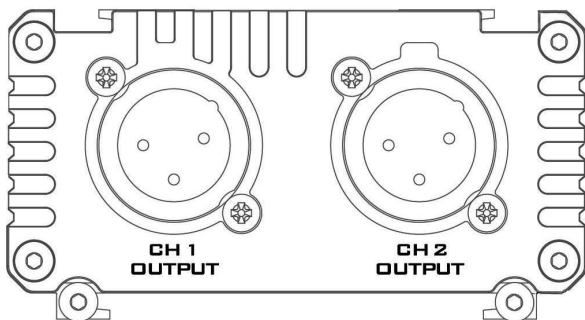

CH1 /CH2 Audio Output

XLR Balanced Audio output (Channel 1 / 2).

Dac-80 Electronic Circuit Diagram

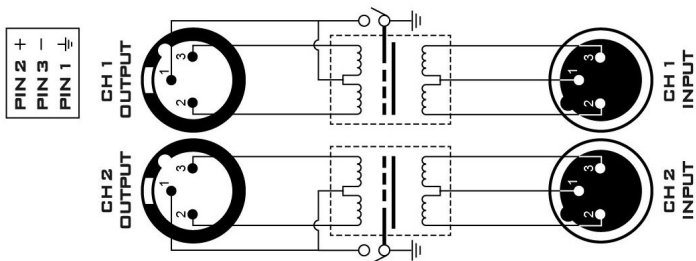

System Diagram

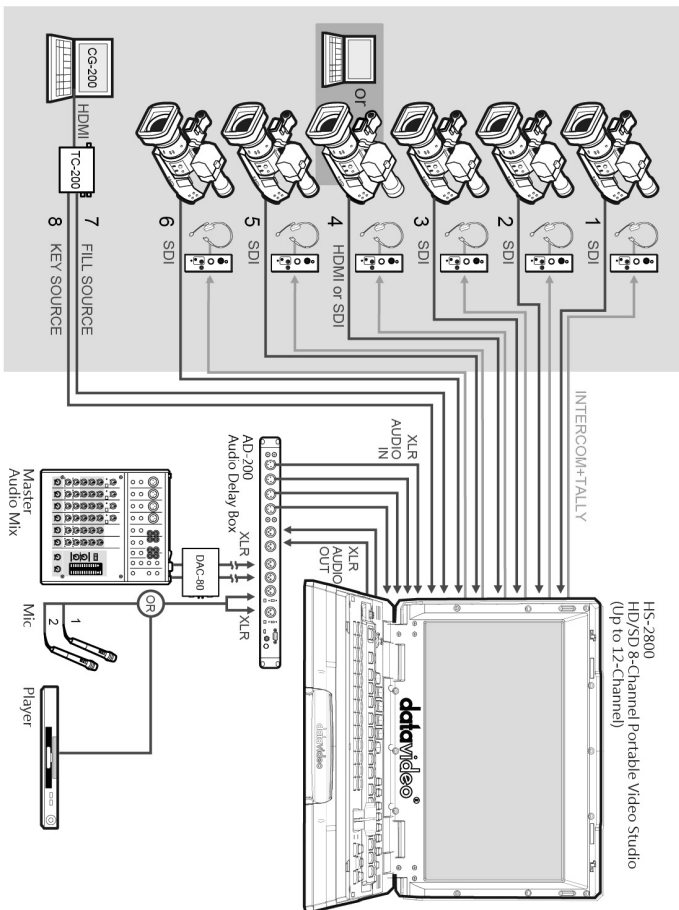

Specifications

Impedance	600Ω+/- 10%(Input & output)
Bandwidth Frequency	20Hz ~20KHz ±0.5dB
THD: 1KHz	< 0.015% @ +4dBu; 20Hz: 0.05% @+4dBu
Insertion loss	<0.5dB
Turns Ration	1:1
Input	2Ch XLR Audio Input
Output	2Ch XLR Audio Output
Dimensions	85mm x 45.2mm x 111.5mm (W x H x D)

Service & Support

It is our goal to make owning and using Datavideo products a satisfying experience. Our support staff is available to assist you to set up and operate your system. Contact your local office for specific support requests. Plus, please visit www.datavideo.com to access our FAQ section.

USA: Datavideo Corporation

Tel: +1 562 696 2324	Fax: +1 562-698-6930	E-Mail: techsupport@datavideo.us
----------------------	----------------------	----------------------------------

The Netherland: Datavideo Technologies Europe BV

Tel: +31-30-261-96-56	Fax: +31-30 261-96-57	E-Mail: service@datavideo.nl
-----------------------	-----------------------	------------------------------

United Kingdom: Datavideo UK Limited

Tel: +44 1457 851 000	Fax: +44 1457 850 964	E-Mail: sales@datavideo.co.uk
-----------------------	-----------------------	-------------------------------

Taiwan: Datavideo Technologies Co., Ltd

Tel: +886 2 8227 2888	Fax: +886-2-8227-2777	E-mail: service@datavideo.com.tw
-----------------------	-----------------------	----------------------------------

China: Datavideo Technologies China Co., Ltd

Tel: +86 21-5603 6599	Fax: +86 21-5603 6770	E-mail: service@datavideo.cn
-----------------------	-----------------------	------------------------------

Singapore: Datavideo Technologies (S) PTE LTD

Tel: +65-6749 6866	Fax: +65-6749 3266	E-mail: sales@datavideo.sg
--------------------	--------------------	----------------------------

Hong Kong: Datavideo HK Limited

Tel: +852 2833 1981	Fax: +852-2833-9916	E-mail: info@datavideo.com.hk
---------------------	---------------------	-------------------------------

France: Datavideo France

Tel: +33 1 60 37 02 46	Fax: +33 1 60 37 67 32	E-Mail: info@datavideo.fr
------------------------	------------------------	---------------------------

India: Datavideo India

Tel: +91-0120-2427337	Fax: +91-0120-2427338	E-Mail: sales@datavideo.in
-----------------------	-----------------------	----------------------------

All the trademarks are the properties of their respective owners.
Datavideo Technologies Co., Ltd. All rights reserved 2018

Mar-31.2014 P/N: G082060725B1